

[ 1 ] \* 1

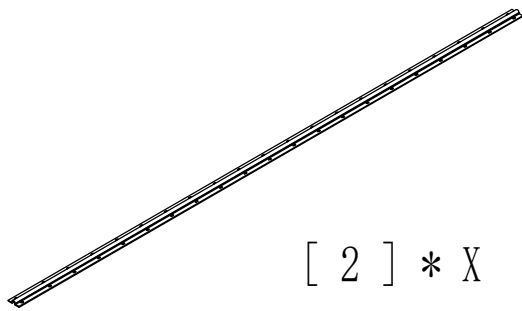

[ 2 ] \* X



[ 3 ] \* 1



[ 4 ] \* 3

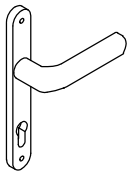

[ 5 ] \* 2



[ 6 ] \* 1

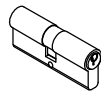

[ 7 ] \* 1



[ 8 ] \* 1



[ 9 ] \* 3

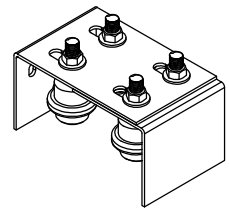

[ 10 ] \* 1

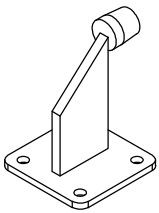

[ 11 ] \* 1

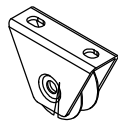

[ 12 ] \* 2

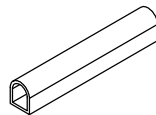

[ 13 ] \* X



[ 14 ] \* X

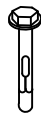

[ 15 ] \* 13



[ 16 ] \* 1



[ 17 ] \* 2



[ 18 ] \* 8



[ 19 ] \* 2



[ 20 ] \* 2



[ 21 ] \* 4

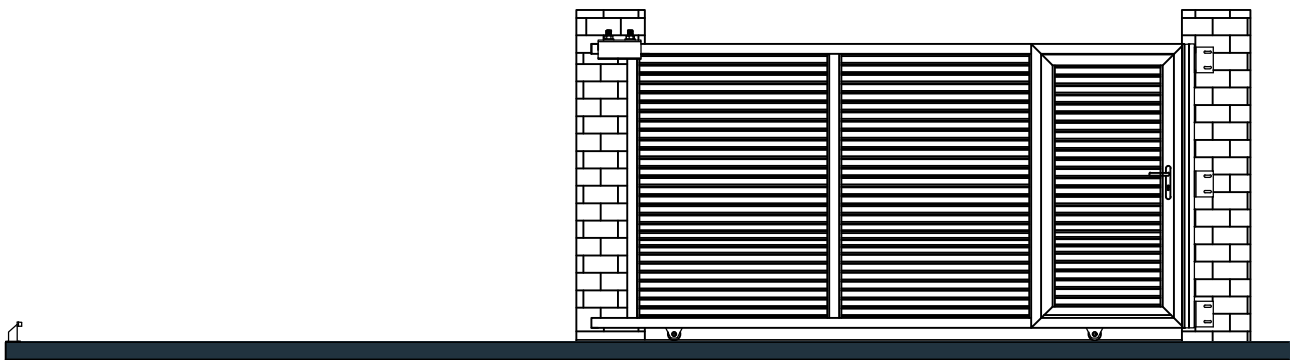
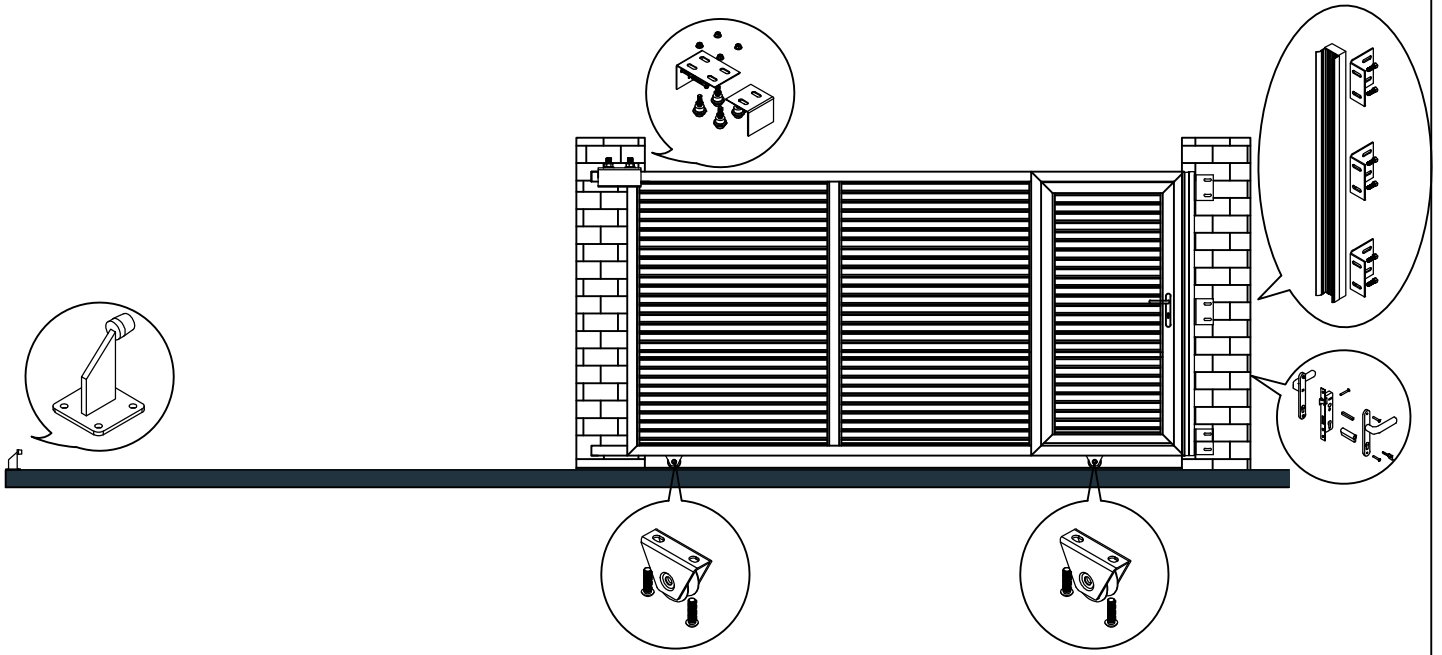

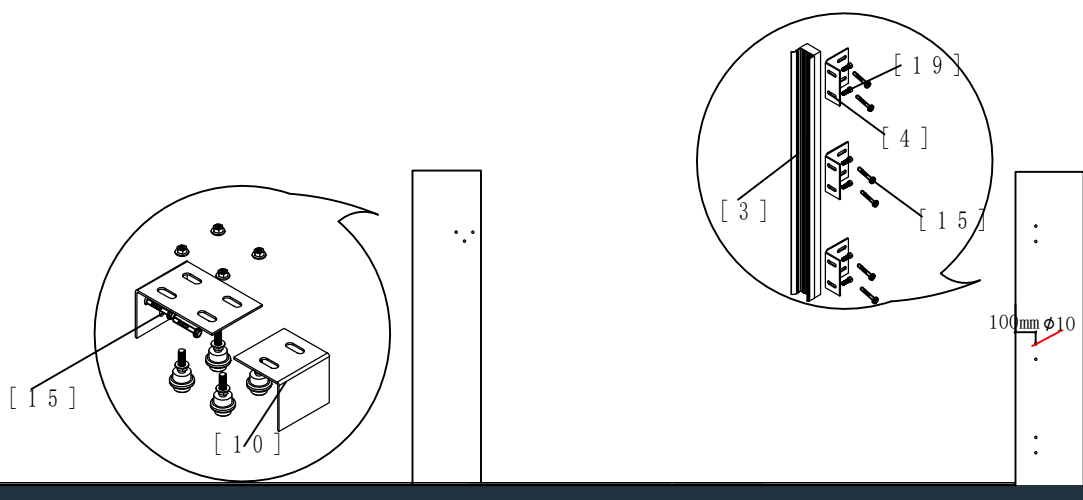
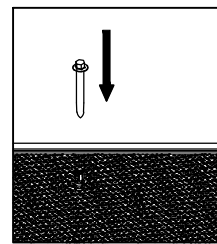
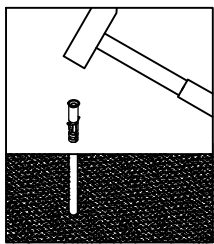
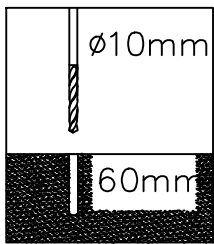
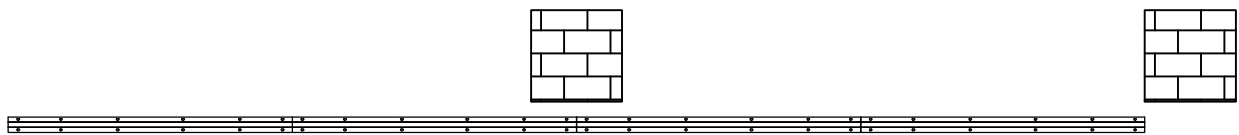
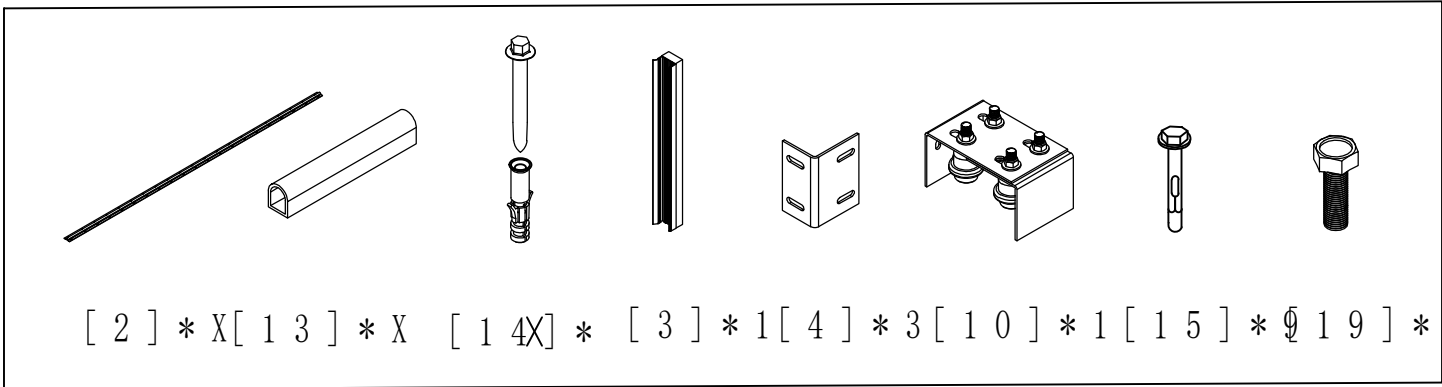

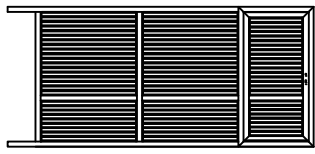

[ 1 ] \* 1

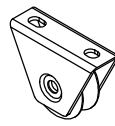

[ 1 2 ] \* 2 [ 1 8 ] \* 4

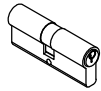
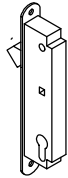
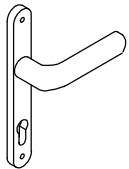

[ 5 ] \* 2

[ 6 ] \* 1

[ 7 ] \* 1

[ 8 ] \* 1

[ 9 ] \* 3

[ 1 6 ] \* 2

[ 1 7 ] \* 1

[ 2 0 ] \* 2

